

# Flexible Radio: A Framework for Optimized Multimodal Operation via Dynamic Signal Design

## **Ioannis Dages**

*Institute of Accelerating Systems & Applications (IASA), National Kapodistrian University of Athens (NKUA),  
P.O. Box 17214, 10024 Athens, Greece  
Email: jdages@phys.uoa.gr*

## **Andreas Zalonis**

*Institute of Accelerating Systems & Applications (IASA), National Kapodistrian University of Athens (NKUA),  
P.O. Box 17214, 10024 Athens, Greece  
Email: azalonis@phys.uoa.gr*

## **Nikos Dimitriou**

*Institute of Accelerating Systems & Applications (IASA), National Kapodistrian University of Athens (NKUA),  
P.O. Box 17214, 10024 Athens, Greece  
Email: nikodim@phys.uoa.gr*

## **Konstantinos Nikitopoulos**

*Institute of Accelerating Systems & Applications (IASA), National Kapodistrian University of Athens (NKUA),  
P.O. Box 17214, 10024 Athens, Greece  
Email: cnikit@cc.uoa.gr*

## **Andreas Polydoros**

*Institute of Accelerating Systems & Applications (IASA), National Kapodistrian University of Athens (NKUA),  
P.O. Box 17214, 10024 Athens, Greece  
Email: polydoros@phys.uoa.gr*

*Received 16 March 2005; Revised 19 April 2005*

The increasing need for multimodal terminals that adjust their configuration on the fly in order to meet the required quality of service (QoS), under various channel/system scenarios, creates the need for flexible architectures that are capable of performing such actions. The paper focuses on the concept of flexible/reconfigurable radio systems and especially on the elements of flexibility residing in the PHYSical layer (PHY). It introduces the various ways in which a reconfigurable transceiver can be used to provide multistandard capabilities, channel adaptivity, and user/service personalization. It describes specific tools developed within two IST projects aiming at such flexible transceiver architectures. Finally, a specific example of a mode-selection algorithmic architecture is presented which incorporates all the proposed tools and, therefore, illustrates a baseband flexibility mechanism.

**Keywords and phrases:** flexible radio, reconfigurable transceivers, adaptivity, MIMO, OFDM.

## **1. INTRODUCTION**

The emergence of speech-based mobile communications in the mid 80s and their exponential growth during the 90s have paved the way for the rapid development of new wireless standards, capable of delivering much more advanced services to the customer. These services are and

will be based on much higher bit rates than those provided by GSM, GPRS, and UMTS. The new services (video streaming, video broadcasting, high-speed Internet, etc.) will demand much higher bit rates/bandwidths and will have strict QoS requirements, such as the received BER and the end-to-end delay. The new and emerging standards (WiFi, WiMax, DVB-T, S-DMB, IEEE 802.20) will have to compete with the ones based on wired communications and overcome the barriers posed by the wireless medium to provide seamless coverage and uninterrupted communication.

---

This is an open access article distributed under the Creative Commons Attribution License, which permits unrestricted use, distribution, and reproduction in any medium, provided the original work is properly cited.

Another issue that is emerging pertains to the equipment that will be required to handle the plethora of the new standards. It will be highly unlikely that the user will have available a separate terminal for each of the introduced standards. There will be the case that the use of a specific standard will be dictated by factors such as the user location (inside buildings, in a busy district, or in a suburb), the user speed (pedestrian, driving, in a high-speed train), and the required quality (delay sensitivity, frame error rate, etc.). There might also be cases in which it would be preferred that a service was delivered using a number of different standards (e.g., WiFi for video, UMTS for voice), based on some criteria related to the terminal capabilities (say, power consumption) and the network capacity constraints. Therefore, the user equipment has to follow the rapid development of new wireless standards by providing enough flexibility and agility to be easily upgradeable (with perhaps the modification/addition of specific software code but no other intervention in hardware).

We note that flexibility in the terminal concerns both the analog/front-end (RF/IF) as well as digital (baseband) parts. The paper will focus on the issues pertaining to the baseband flexibility and will discuss its interactions with the procedures taking place in the upper layers.

## 2. DEFINITIONS OF RADIO FLEXIBILITY

The notion of *flexibility* in a radio context may be defined as an umbrella concept, encompassing a set of nonoverlapping (in a conceptual sense) postulates or properties (each of which must be defined individually and clearly for the overall definition to be complete) such as *adaptivity*, *reconfigurability*, *modularity*, *scalability*, and so on. The presence of any subset of such features would suffice to attribute the qualifying term *flexible* to any particular radio system [1]. These features are termed “nonoverlapping” in the sense that the occurrence of any particular one does not predicate or force the occurrence of any other. For example, an adaptive system may or may not be reconfigurable, and so on. Additional concepts can be also added, such as “ease of use” or “seamlessly operating from the user’s standpoint,” as long as these attributes can be quantified and identified in a straightforward way, adding a new and independent dimension of flexibility. *Reconfigurability*, for instance, which is a popular dimension of flexibility, can be defined as the ability to rearrange various modules at a structural or architectural level by means of a nonquantifiable<sup>1</sup> change in its configuration. *Adaptivity*, on the other hand, can be defined as the radio system response to changes by properly altering the numerical value of a set of parameters [2, 3]. Thus, adaptive transmitted (Tx) power or adaptive bit loading in OFDM naturally fall in the latter category, whereas dynamically switching between, say, a turbo-coded and a convolutional-coded system in response to some stimulus (or information) seems to fit better the code-reconfigurability label, simply because that type of

change implies a circuit-design change, not just a numeric parameter change. Furthermore, the collection of adaptive and reconfigurable transmitted-signal changes in response to some channel-state-information feedback may be termed dynamic signal design (DSD). Clearly, certain potential changes may fall in a grey area between definitions.<sup>2</sup>

A primitive example of flexibility is the multiband operation of current mobile terminals, although this kind of flexibility driven by the operator is not of great research interest from the physical-layer point of view. A more sophisticated version of such a flexible transceiver would be the one that has the intelligence to autonomously identify the incumbent system configuration and also has the further ability to adjust its circumstances and select its appropriate mode of operation accordingly. Software radio, for example, is meant to exploit reconfigurability and modularity to achieve flexibility. Other approaches may encompass other dimensions of flexibility, such as adaptivity in radio resource management techniques.

## 3. FLEXIBILITY SCENARIOS

In response to the demand for increasingly flexible radio systems from industry (operators, service providers, equipment manufacturers, chip manufacturers, system integrators, etc.), government (military communication and signal-intelligence systems), as well as various user demands, the field has grown rapidly over the last twenty years or so (perhaps more in certain quarters), and has intrigued and activated R&D Departments, academia, research centers, as well as funding agencies. It is now a rapidly growing field of inquiry, development, prototyping, and even fielding. Because of the enormity of the subject matter, it is hard to draw solid boundaries that exclusively envelop the scientific topic, but it is clear that such terms as SR, SDR, reconfigurable radio, cognitive/intelligent/smart radio, and so on are at the center of this activity. Similar arguments would include work on flexible air-interface waveforms and/or generalized (and properly parameterized) descriptions and receptions thereof. Furthermore, an upward look (from the physical-layer “bottom” of the communication-model pyramid) reveals an ever-expanding role of research on networks that include reconfigurable topologies, flexible medium-access mechanisms, interlayer optimization issues, agile spectrum allocation [4], and so on. In a sense, *ad hoc* radio networks fit the concept, as they do not require any rigid or fixed infrastructure. Similarly, looking “down” at the platform/circuit level [5], we see intense activity on flexible and malleable platforms and designs that are best suited for accommodating such flexibility. In other words, every component of the telecommunication

<sup>1</sup>“Nonquantifiable” here means that it cannot be represented by a numerical change in a parametric set.

<sup>2</sup>This terminology is to a certain degree arbitrary and not universally agreed upon; for instance, some authors call a radio system “reconfigurable” because “it is adaptive,” meaning that it adapts to external changes. On the other hand, the term “adaptive” has a clear meaning in the signal-processing-algorithms literature (e.g., an adaptive equalizer is the one whose coefficient values change slowly as a function of the observation), and the definition proposed here conforms to that understanding.

and radio universe can be seen as currently participating in the radio-flexibility R&D work, making the field exciting as well as difficult to describe completely.

Among the many factors that seem to motivate the field, the most obvious seems to be the need for multistandard, multimode operation, in view of the extreme proliferation of different, mutually incompatible radio standards around the globe (witness the “analog-to-digital-to-wideband-to-multicarrier” evolution of air interfaces in the various cellular-system generations). The obvious desire for having a single-end device handling this multitude in a compatible way is then at the root of the push for flexibility. This would incorporate the desire for “legacy-proof” functionality, that is, the ability to handle existing systems in a single unified terminal (or single infrastructure access point), regardless of whether this radio system is equipped with all the related information prestored in memory or whether this is software-downloaded to a generically architected terminal; see [6] for details. In a similar manner, “future-proof” systems would employ flexibility in order to accommodate yet-unknown systems and standards with a relative ease (say, by a mere resetting of the values of a known set of parameters), although this is obviously a harder goal to achieve than legacy-proofness. Similarly, economies of scale dictate that radio transceivers employ reusable modules to the degree possible (hence the modularity feature). Of course, truly optimized designs for specific needs and circumstances, lead to “point solutions,” so that flexibility of the modular and/or generic waveform-design sort may imply some performance loss. In other words, the benefit of flexibility may come at some cost, but hopefully the tradeoff is still favorable to flexible designs.

There are many possible ways to exploit the wide use of a single flexible reconfigurable baseband transceiver, either on the user side or on the network side. One scenario could be the idea of location-based reconfiguration for either multi-service ability or seamless roaming. A flexible user terminal can be capable of reconfiguring itself to whichever standard prevails (if there are more than one that can be received) or exists (if it is the only one) at each point in space and time, either to be able to receive the ever-available (but possibly different) service or to receive seamlessly the same service. Additionally, the network side can make use of the future-proof reconfiguration capabilities of its flexible base stations for “soft” infrastructure upgrading. Each base station can be easily upgradeable to each current and future standard. Another interesting scenario involves the combined reception of the same service via more than one standard in the same terminal. This can be envisaged either in terms of “standard selection diversity,” according to which a flexible terminal will be able to download the same service via different air-interface standards and always sequentially (in time) select the optimum signal (to be processed through the same flexible baseband chain) or, in terms of service segmentation and standard multiplexing, meaning that a flexible terminal will be able to collect frames belonging to the same service via different standards, thus achieving throughput maximization for that service, or receive different services (via different standards) simultaneously. Finally, another flexibility

scenario could involve the case of peer-to-peer communication whereby two flexible terminals could have the advantage of reconfiguring to a specific PHY (according to conditions, optimization criteria) and establish a peer-to-peer *ad hoc* connection.

The aforementioned scenarios of flexibility point to the fact that the elements of wireless communications equipment (on board both future terminals and base station sites) will have to fulfill much more complicated requirements than the current ones, both in terms of multistandard capabilities as well as in terms of intelligence features to control those capabilities. For example, a flexible terminal on either of the aforementioned scenarios must be able to sense its environment and location and then alter its transmission and reception parameters (frequency band, power, frequency, modulation, and other parameters) so as to dynamically adapt to the chosen standard/mode. This could in theory allow a multidimensional reuse of spectrum in space, frequency, and time, overcoming the various spectrum usage limitations that have slowed broadband wireless development and thus lead to one vision of *cognitive radio* [7], according to which radio nodes become radio-domain-aware intelligent agents that define optimum ways to provide the required QoS to the user.

It is obvious that the advantageous operation of a truly flexible baseband/RF/IF platform will eventually include the use of sophisticated MAC and RRM functionalities. These will have to regulate the admission of new users in the system, the allocation of a mode/standard to each, the conditions of a vertical handover (from one standard to another), and the scheduling mechanisms for packet-based services. The criteria for assigning resources from a specific mode to a user will depend on various parameters related to the wireless channel (path loss, shadowing, fast fading) and to the specific requirements imposed by the terminal capabilities (minimization of power consumption and transmitted power), the generated interference, the user mobility, and the service requirements. That cross-layer interaction will lead to the ultimate goal of increasing the multiuser capacity and coverage while the power requirements of all flexible terminals will be kept to a minimum required level.

#### 4. FLEXIBLE TRANSCEIVER ARCHITECTURE AT THE PHY-DYNAMIC SIGNAL DESIGN

##### 4.1. Transmission schemes and techniques

Research exploration of the next generation of wireless systems involves the further development of technologies like OFDM, CDMA, MC-CDMA, and others, along with the use of multiple antennas at the transmitter and the receiver. Each of these techniques has its special benefits in a specific environment: for example, OFDM is used successfully in WLAN systems (IEEE 802.11a), whereas CDMA is used successfully in cellular 2G (IS-95) and 3G (UMTS) systems. The selection of a particular one relies on the operational environment of each particular system. In OFDM, the available signal bandwidth is split into a large number of subcarriers, orthogonal to each other, allowing spectral overlapping without

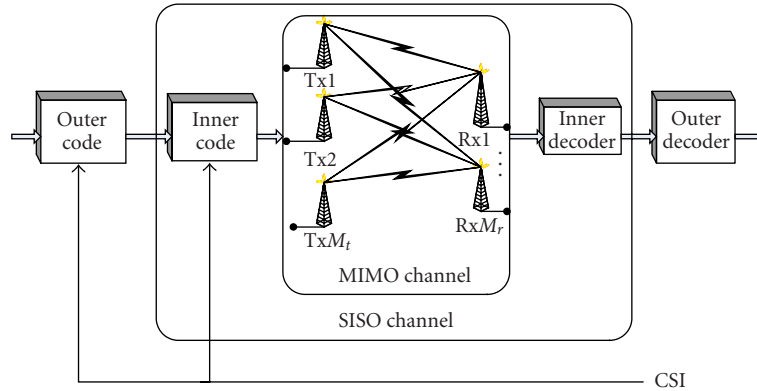

FIGURE 1: MIMO code design procedure.

interference. The transmission is divided into parallel subchannels whose bandwidth is narrow enough to make them effectively frequency flat. A cyclic prefix is used to combat ISI, in order to avoid (or simplify) the equalizer [8].

The combination of OFDM and CDMA, known as MC-CDMA [9], has gained attention as a powerful transmission technique. The two most frequently investigated types are multicarrier CDMA (MC-CDMA) which employs frequency-domain spreading and multicarrier DS-SS-CDMA (MC-DS-CDMA) which uses time-domain spreading of the individual subcarrier signals [9, 10]. As discussed in [9], MC-CDMA using DS spread subcarrier signals can be further divided into multitone DS-SS-CDMA, orthogonal MC-DS-CDMA, and MC-DS-CDMA using no subcarrier overlapping. In [11, 12], it is shown that the above three types of MC-DS-CDMA schemes with appropriate frequency spacing between two adjacent subcarriers can be unified in the family of generalized MC-DS-CDMA schemes.

Multiple antennas with transmit and receive diversity techniques have been introduced to improve communication reliability via the diversity gain [13]. Coding gain can also be achieved by appropriately designing the transmitted signals, resulting in the introduction of space-time codes (STC). Combined schemes have already been proposed in the literature. MIMO-OFDM has gained a lot of attention in recent years and intensive research has already been performed. Generalized MC-DS-CDMA with both time- and frequency-domain spreading is proposed in [11, 12] and efforts on MIMO MC-CDMA can be found in [14, 15, 16, 17, 18].

#### 4.2. Dynamic signal design

Flexible systems do not just incorporate all possible point solutions for delivering high QoS under various scenarios, but possess the ability to make changes not only on the algorithmic but also on the structural level in order to meet their goals. Thus, the DSD goal is to bring the classic design procedure of the PHY layer into the intelligence of the transceiver and initiate new system architectural approaches, capable of creating the tools for on-the-fly reconfiguration. The module responsible for all optimization actions is herein called *supervisor*, also known as *controller* and the like.

The difference between adaptive modulation and coding (AMC) and dynamic signal design (DSD) is that AMC is a design approach with a main focus on developing algorithms for *numerical* parameter changes (constellation size, Tx power, coding parameters), based on appropriate feedback information, in order to approach the capacity of the underlying channel. The type of channel code in AMC is predetermined for various reasons, such as known performance of a given code in a given channel, compatibility with a given protocol, fixed system complexity, and so on. Due to the variety of channel models, system architectures, and standards, there is a large number of AMC point solutions that will succeed in the aforementioned capacity goal.

In a typical communication system design, the algorithmic choice of most important functional blocks of the PHY layer is made once at design time, based on a predetermined and restricted set of channel/system scenarios. For example, the channel waveform is selected based on the channel (fast fading, frequency selective) and the system characteristics (multi/single-user, MIMO). On the other hand, truly flexible transceivers should not be restricted to one specific scenario of operation, so that the choice of channel waveform, for instance, must be broad enough to adapt either parametrically or structurally to different channel/system conditions. One good example of such a flexible waveform would be fully parametric MC-CDMA, which can adjust its spreading factor, the number of subcarriers, the constellation size, and so on. Similarly, MIMO systems that are able to change the number of active antennas or the STC, on top of a flexible modulation method like MC-CDMA, can provide a large number of degrees of freedom to code designers.

With respect to the latter point, we note that STC design has relied heavily on the pioneering work of Tarokh et al. in [19], where design principles were first established. Recent overall code design approaches divide coding into *inner* and *outer* parts (see Figure 1), in order to produce easily implementable solutions [20, 21]. Inner codes are the so-called ST codes, whereas outer codes are the classic SISO channel codes. Each entity tries to exploit a different aspect of channel properties in order to improve the overall system performance. Inner codes usually try to get

TABLE 1: Flexible design tools and inputs.

Physical-layer flexibility	Modulation (a flexible scheme like MC-CDMA)	Space-time coding	Channel coding
Tools	Adjustable FFT size, spreading code length, constellation size (bit loading), Tx power per carrier (power loading)	Adjustable number of Tx/Rx antennas used, flexible ST coding scheme as opposed to (diversity/multiplexing/coding/SNR gain)	Flexible FEC codes (e.g., turbo, convolutional, LDPC) with adjustable coding rate, block size, code polynomial
Inputs	Number of users sharing the same BW, channel type (indoor/outdoor)	Channel variation in time (Doppler), Rx antenna correlation factor, feedback delay, goodness of channel estimation	Effective channel parameters (including STC effects)

diversity/multiplexing/SNR gain, while outer codes try to get diversity/coding gain. The best choice of an inner/outer code pair relies on channel characteristics, complexity, and feedback-requirement (CSI) considerations.

There are several forms of diversity that a system can offer, such as time, frequency, and space. The ability to change the number of antennas, subcarriers, spreading factor and the ST code provides great control for the purpose of reaching the diversity offered by the current working environment. There are many STCs presented in the literature which exploit one form of diversity in a given system/environment. All these point solutions must be taken into account in order to design a system architecture that efficiently incorporates most of them.

Outer channel codes must also be chosen so as to obtain the best possible overall system performance. In some cases, the diversity gain of the cascade coding can be analytically derived, based on the properties of both coding options [20]. Even in these idealized scenarios, however, individually maximizing the diversity gain of both codes does not improve performance. This means that, in order to maximize the overall performance of the system, a careful tradeoff is necessary between multiplexing gain, coding gain, and SNR gain.

New channel estimation methods must also be developed in order to estimate not only the channel gain values but also other related inputs (see Table 1). For example, the types of diversity that can be exploited by the receiver or the correlation factor between multiple antennas are important inputs for choosing the best coding option. Another input is the channel rate of change (Doppler), normalized to the system bandwidth, in order to evaluate the feedback delay. In most current AMC techniques, this kind of input information has not been employed, since the channel characteristics have not been considered as system design variables.

## 5. FLEXIBILITY TOOLS

The paper is based on techniques developed in two IST projects, WIND-FLEX and Stingray. The main goal of WIND-FLEX was the development of flexible (in the

sense of Section 2) architectures for indoor, high-bit-rate wireless modems. OFDM was the signal modulation of choice [22], along with a powerful turbo-coded scheme. The Stingray Project targeted a Hiperman-compatible [23] MIMO-OFDM system for Fixed Wireless Access (FWA) applications. It relied on a flexible architecture that exploited the *channel state information* (CSI) provided by a feedback channel from the receiver to the transmitter, driven by the needs of the supported service.

In the following sections, the key algorithmic choices of both projects are presented, which can be incorporated in a *single* design able to operate in a variety of environments and system configurations. Since a flexible transceiver must operate under starkly different channel scenarios, the transmission-mode-selection algorithm must rely solely on instantaneous channel measurements and not on the average behavior of a specific channel model. This imposes the restriction of low channel dynamics in order to have the benefit of feedback information. On both designs, a maximum of one bit per carrier is allowed for feedback information, along with the mode selection number. The simplicity of this feedback information makes both designs robust to channel estimation errors or feedback delay.

### 5.1. AMC in WIND-FLEX

The WIND-FLEX (WF) system was placed in the 17 GHz band, and has been measured to experience high frequency selectivity within the 50 MHz channel widths. The result is strong performance degradation due to few subcarriers experiencing deep spectral nulls. Even with a powerful coding scheme such as turbo codes, performance degradation is unacceptable. The channel is fairly static for a large number of OFDM symbols, allowing for efficient design of adaptive modulation algorithms in order to deal with this performance degradation. In order to keep implementation complexity at a minimum, and also to minimize the required channel feedback traffic, two design constraints have been adopted: same constellation size for all subcarriers, as well as same power for all within an OFDM symbol, although both these parameters are adjustable (adaptive).

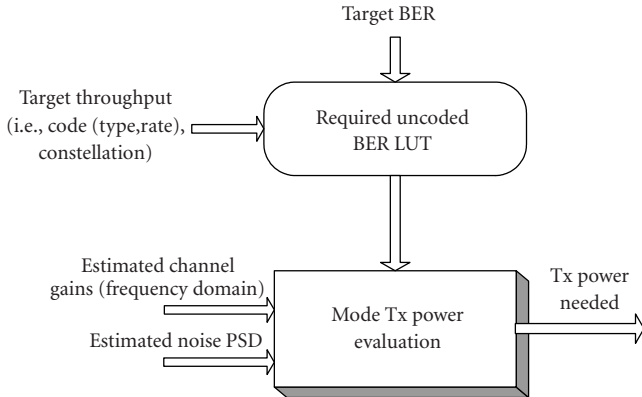

FIGURE 2: Simplified block diagram of algorithm 1.

Two algorithms have been proposed in order to optimize the performance. The first algorithm (Figure 2) evaluates the required Tx power for a specific code, constellation, and channel realization to achieve the target BER. If the required power is greater than the maximum available/allowable Tx power, a renegotiation of the target QoS (lowering the requirements) takes place. This approach exhibits low complexity and limited feedback information requirements. The relationship of the uncoded versus the coded BER performance in an OFDM system have been given in [24] for turbo codes and can be easily extended to convolutional codes. An implementation of this algorithm is described in [25].

The large SNR variation across the subcarriers of OFDM degrades system performance even when a strong outer code is used. To counter, the technique of Weak Subcarrier excision (WSCE) is introduced as a way to exclude a certain number of subcarriers from transmission. The second proposed algorithm employs WSCE along with the appropriate selection of code/constellation size. This is called the “coded weak subcarrier excision” (CWSCE) method.

In WIND-FLEX channel scenarios performance improved when using a fixed number of excised subcarriers. The bandwidth penalty introduced by this method was compensated by the ability to use higher code rates. In Figure 3, bit error rate (BER) simulation curves are shown for the uncoded performance of fixed WSCE and are compared with the bit loading algorithm presented in [26] for the NLOS channel scenario. {Rate 1} and {Rate 2} are the system throughputs when using 4-QAM with 10% and 20% WSCE, respectively. The BER performance without bit loading or WSCE is also plotted for a 4-QAM constellation.

There is a clear improvement by just using a fixed WSCE scheme, and there is a marginal loss in comparison to the nearly optimum bit-loading algorithm. Based on the average SNR across the subcarriers, semianalytic computation of the average and outage capacity for the effective channel is possible in order to evaluate a performance upper bound of a system employing such WSCE plus uniform power loading. The use of an outer code helps to come close to this bound. We note that the average capacity of an OFDM system without

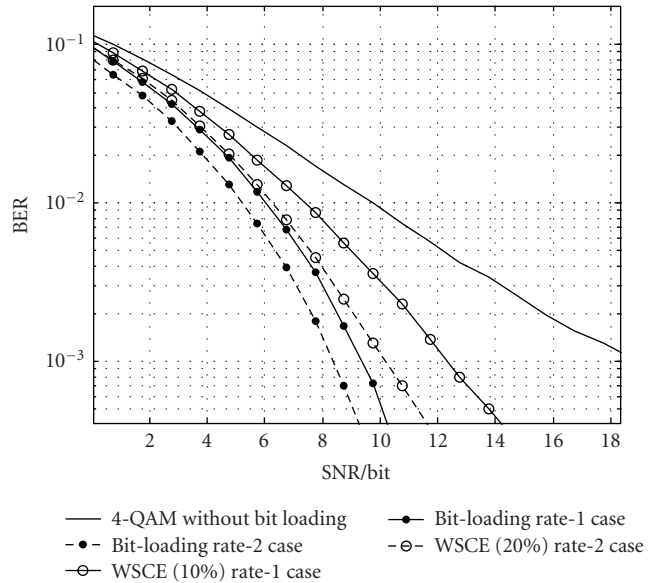

FIGURE 3: Uncoded performance for WIND-FLEX NLOS channel.

power-loading techniques is

$$C^E = E \left\{ \frac{1}{N} \sum_{k=1}^N \log_2 (1 + \text{SNR}_k) \right\} \text{ bits/carrier,} \quad (1)$$

where the expectation operator is over the stochastic channel. For a system employing WSCE, the summation is over the used carriers along with appropriate transmit energy normalization. These capacity results are based on the “quasistatic” assumption. For each burst, it is also assumed that a sufficiently large number of bits are transmitted, so that the standard infinite time horizon of information theory is meaningful. In Figure 4, the system average capacity (SAC) and the 1% system outage capacity (SOC) of the WF system employing various WSCE scenarios are presented. Here, the definitions are as follows.

- (i) SAC (system average capacity). This is equivalent to the mean or ergodic capacity [27] applied to the effective channel. It serves as an upper bound of systems with boundless complexity or latency that use a specific inner code.
- (ii) SOC (system outage capacity). This is the 1% outage capacity of the STC-effective channel.
- (iii) AC and OC. This is the average capacity and outage capacity of the actual sample-path channel.

The capacity of an AWGN channel is also plotted as an upper bound for a given SNR. At low SNR regions, the capacity of a system employing as high as 30% WSCE is higher than a system using all carriers without power loading. At high SNR, the capacity loss asymptotically approaches the bandwidth percentage loss of WSCE. The capacity using adaptive WSCE is also plotted. In some channel realizations,

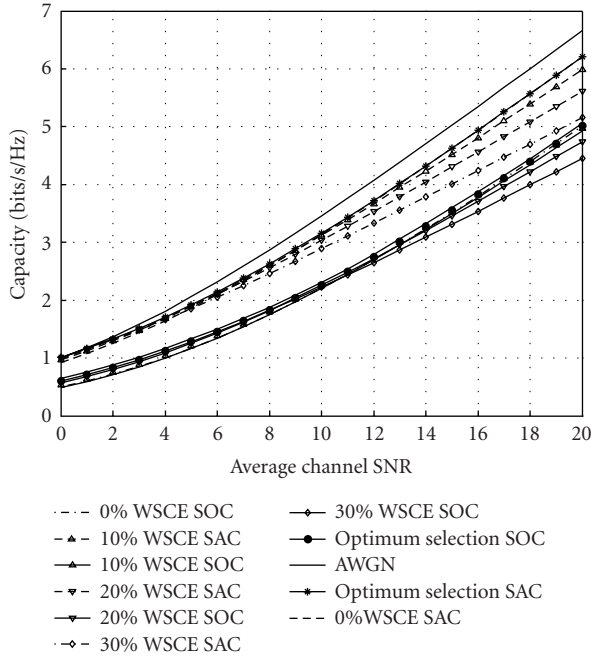

FIGURE 4: System average capacity and system 1% outage capacity of different WSCE options.

in the low-to-medium SNR region, a 30% to 50% WSCE is needed. This result motivates the design of the second algorithm. The impact of CWSCE is the ability to choose between different code rates for the same target rate, a feature absent from the first algorithm. Assume an ordering of the different pairs {code rate-constellation size} based on the SNR necessary to achieve a certain BER performance. It is obvious that this ordering also applies to the throughput of each pair (a system will not include pairs that need more power to provide lower throughput). For each of these pairs, the fixed percentage of excised carriers is computed so that they all provide the same final (target) throughput.

The block diagram of CWSCE algorithm is given in Figure 5. The respective definitions are as follows:

- (i)  $x_i$ ,  $i = 1, \dots, l$ , is one of the system-supported constellations;
- (ii)  $y_i$ ,  $i = 1, \dots, M$ , is one of the supported outer channel codes. These can be totally different codes like turbo, convolutional, LDPC, or the codes resulting from puncturing one mother code, or both;
- (iii)  $z_i$ ,  $i = 1, \dots, n$ , are the resulting WSCE percentages for the  $n$  competitive triplets;
- (iv)  $\text{Pos}(z_i)$  are the positions of the  $z_i\%$  of weakest gains.
- (v)  $\mathbf{H}$  is the vector of the estimated channel gains in the frequency domain;
- (vi)  $\hat{N}_0$  is the estimated power spectral density of the noise.
- (vii)  $\text{RUB}_i$ ,  $i = 1, \dots, n$ , is the required uncoded BER for constellation  $x_i$  and code  $y_i$ ;
- (viii)  $PTx_i$ ,  $i = 1, \dots, n$ , is the required Tx power for the  $i$ th triplet.

The algorithm calculates the triplet that needs the minimum Tx power for a given target BER. If the minimum required power is greater than the maximum available/allowable Tx power, it renegotiates the QoS. Transmit-power adaptation is usually avoided, although it can be handled with the same algorithm. The triplet selection will still be the one that needs the minimum Tx power. The extra computation load is mainly due to the channel-tap sorting. Proper exploitation of the channel correlation in frequency (coherence bandwidth) can reduce this complexity overhead. Instead of sorting all the channel taps, one can sort groups of highly correlated taps. These groups can be restricted to have an equal number of taps. There are many sorting algorithms in the literature with different performance-versus-complexity characteristics that can be employed, depending on implementation limitations.

Simulation results using algorithm 1 for adaptive transmission-power minimization are presented in Figure 6. The performance gain of the proposed algorithm is shown for 4-QAM, the code rates 1/2 and 2/3. Performance is plotted for no adaptation, as well as for algorithm 1 in an NLOS scenario. The performance over a flat (AWGN) channel is also shown for comparison reasons, since it represents the coded performance limit (given that these codes are designed to work for AWGN channels). The main simulation system parameters are based on the WIND-FLEX platform. It uses a parallel-concatenated turbo code with variable rate via three puncture patterns (1/2, 2/3, 3/4) [28]. The recursive systematic code polynomial used is (13, 15)<sub>oct</sub>. Perfect channel estimation and zero phase noise are also assumed.

In addition to the transmission power gain, the adaptive schemes practically guarantee the desired QoS for every channel realization. Note that in the absence of adaptation, users experiencing “bad” channel conditions will never get the requested QoS, whereas users with a “good” channel would correspondingly end up spending too much power versus what would be needed for the requested QoS. By adopting these algorithms, one computes (for every channel realization) the exact needed power for the requested QoS, and thus can either transmit with minimum power or negotiate for a lower QoS when channel conditions do not allow transmission. An average 2 dB additional gain is achieved by using the second algorithm versus the first one.

## 5.2. Adaptive STC in Stingray

As mentioned, Stingray is a Hiperman-compatible  $2 \times 2$  MIMO-OFDM adaptive system. The adjustment rate, namely, the rate at which the system is allowed to change the Tx parameters, is chosen to be once per frame (one frame = 178 OFDM symbols) and the adjustable sets of the Tx parameters are

- (1) the selected Tx antenna per subcarrier, called transmission selection diversity (TSD),
- (2) the {outer code rate, QAM size} set.

The antenna selection rule in TSD is to choose, for every carrier  $k$ , to transmit from the Tx antenna  $T(k)$  with the

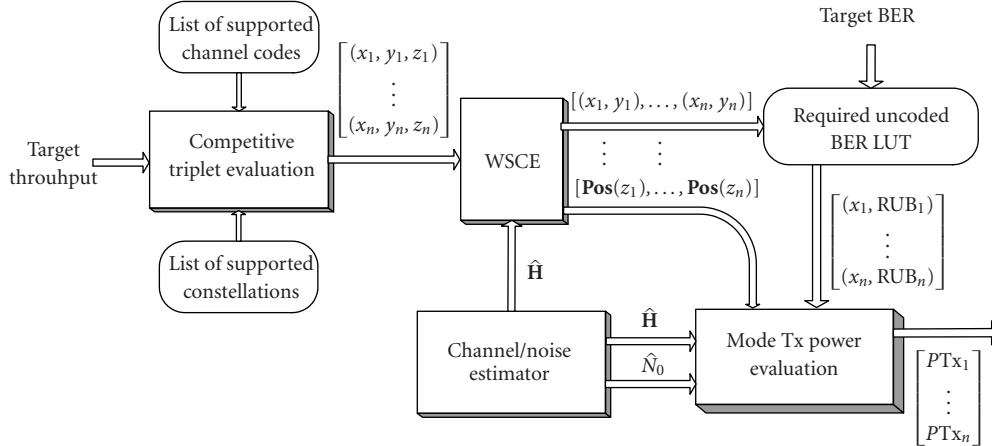

FIGURE 5: Simplified block diagram of algorithm 2.

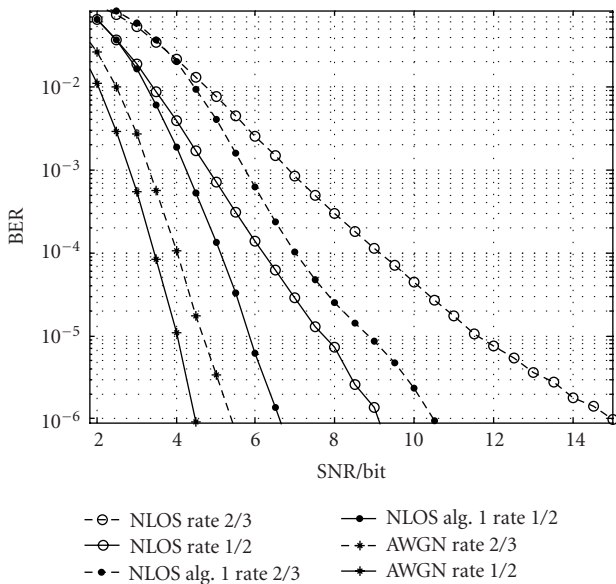

FIGURE 6: Simulation results using algorithm 1: max-log map, 4 iterations, NLOS, 4-QAM, rate = 1/2 and 2/3.

best performance from a maximum-ratio combining (MRC) perspective. For the second set of parameters, the optimization procedure is to choose the set that maximizes the system throughput (bit rate), given a QoS constraint (BER).

In order to identify performance bounds, TSD is compared with two other rate-1 STC techniques, *beamforming* and *Alamouti*. Beamforming is the optimal solution [29] for energy allocation in an  $N_T \times 1$  system with perfect channel knowledge at the transmitter side, whereby the same symbol is transmitted from both antennas multiplied by an appropriate weight factor in order to get the maximum achievable gain for each subcarrier. Alamouti's *STBC* is a blind technique [30], where for each OFDM symbol period two OFDM signals are simultaneously transmitted from the two antennas.

Each of the three STC schemes can be treated as an ordinary OFDM SISO system producing (ideally)  $N$  independent Gaussian channels [31]. This is the effective SISO-OFDM channel. For the Stingray system ( $2 \times 2$ ), the corresponding effective SNR (ESNR) per carrier is as follows:

$$\text{For TSD, } \text{ESNR}_k = \frac{(|H_k^{T(k),0}|^2 + |H_k^{T(k),1}|^2)E_s}{N_0}, \quad (2)$$

$$\begin{aligned} \text{for Alamouti, } \text{ESNR}_k &= \\ &= \frac{(|H_k^{0,0}|^2 + |H_k^{0,1}|^2 + |H_k^{1,0}|^2 + |H_k^{1,1}|^2)E_s}{2N_0}, \end{aligned} \quad (3)$$

$$\text{for beamforming, } \text{ESNR}_k = \frac{\lambda_k^{\max} E_s}{N_0}, \quad (4)$$

where  $\lambda_k^{\max}$  is the square of the maximum eigenvalue of the  $2 \times 2$  channel matrix  $\begin{bmatrix} H_k^{0,0} & H_k^{1,0} \\ H_k^{0,1} & H_k^{1,1} \end{bmatrix}$ ,  $H_k^{i,j}$  is the frequency response of the channel between the Tx antenna  $i$  and Rx antenna  $j$  at subcarrier  $k = 0, 1, \dots, N-1$ , and  $N_0$  is the one-sided power spectral density of the noise in each subcarrier.

In Figure 7, BER simulation curves are presented for all inner code schemes and 4-QAM constellation. Both perfect and estimated CSI scenarios are presented. The channel estimation procedure uses the preamble structure described in [32].

For all simulations, path delays and the power of channel taps have been selected according to the SUI-4 model for intermediate environment conditions [33]. The average channel SNR is employed in order to compare adaptive systems that utilize CSI. Note that this average channel SNR is independent of the employed STC. Having normalized each Tx-Rx path to unit average energy, the channel SNR is equal to one over the power of the noise component of any one of the receivers. Alamouti is the most sensitive scheme to estimation errors. This is expected, since the errors in all four channel taps are involved in the decoding procedure. Based on the ESNR, a semianalytic computation of the average and



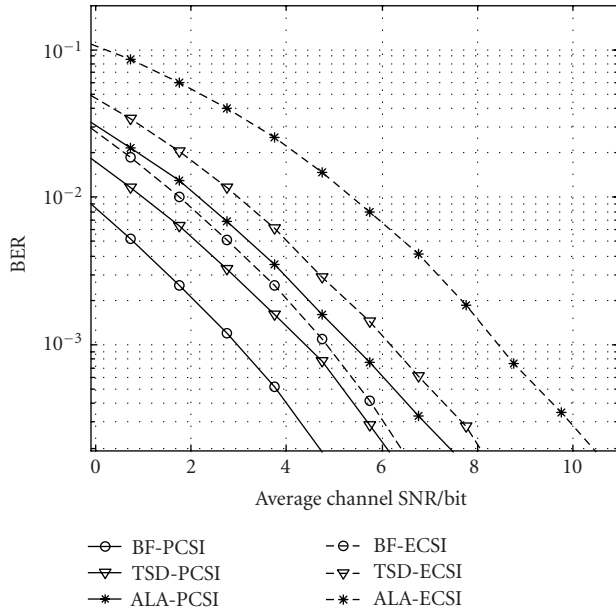

FIGURE 7: STCs BER performance for perfect/estimated CSI (PCSI/ECSI) and 4-QAM constellation.

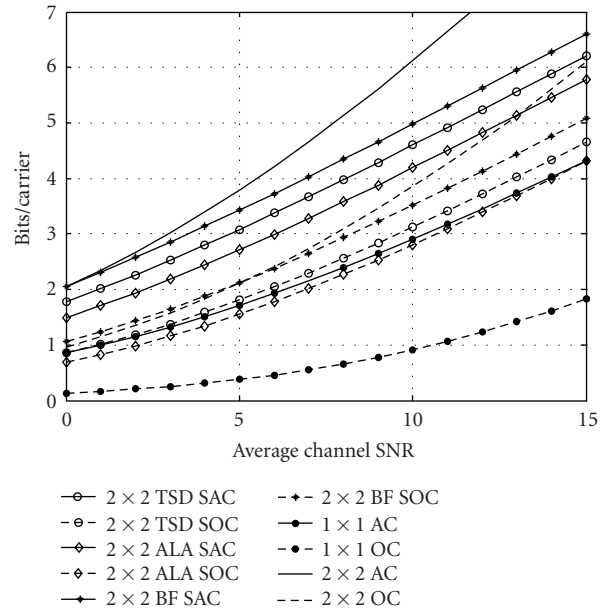

FIGURE 8: System average capacity and system 1% outage capacity of different STC options.

outage capacity for the effective channel is possible in order to evaluate a performance upper bound of these inner codes.

In Figure 8, the average capacity and the 1% outage capacity of the three competing systems are presented. For comparison reasons, the average and outage capacity of the  $2 \times 2$  and  $1 \times 1$  systems with no channel knowledge at the transmitter and perfect knowledge at the receiver are also presented. It is clear that all three systems have the same slope of capacity versus SNR. This is expected, since the rate of all three systems is one. A system exploiting all the multiplexing gain offered by the  $2 \times 2$  channel may be expected to have a slope similar to the capacity of the real channel (AC, OC). It is also evident that the cost of not targeting full multiplexing is a throughput loss compared to that achievable by MIMO channels. On the other hand, the goal of high throughput incurs the price of either enhanced feedback requirements or higher complexity. Comparing the three candidate schemes, we conclude that beamforming is a high-complexity solution with considerable feedback requirements, whereas Alamouti has low complexity with no feedback requirement. TSD has lower complexity than Alamouti, whereas in comparison with beamforming, it has a minimal feedback requirement. The gain over Alamouti is approximately 1.2 dB, while the loss compared to beamforming is another 1.2 dB.

For all schemes, frequency selectivity across the OFDM tones is limited due to the MIMO diversity gain. That is one of the main reasons why bit loading and WSCE gave marginal performance gain. The metric for selecting the second set of parameters was the effective average SNR at the receiver (meaning the average SNR at the demodulator after the ST decoding). The system performance simulation curves based on the SNR at the demodulator (Figure 9) were the basis for the construction of the Tx mode table (TMT),

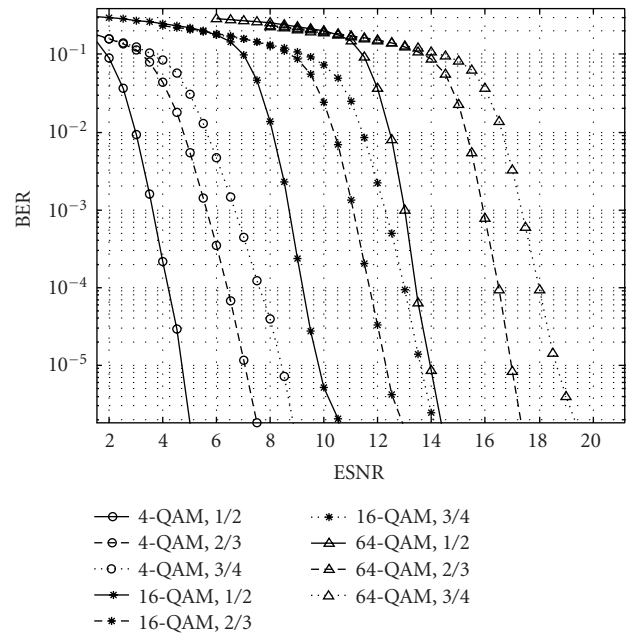

FIGURE 9: TSD-turbo system performance results.

which consists of SNR regions and code-rate/constellation size sets for all the QoS operation modes (BER) that will be supported by the system. The selected inner code is TSD and the outer code is the same used in the WF system. Since perfect channel and noise-power knowledge are assumed, ESNR is in fact the real prevailing SNR. This turns out to be a good performance metric, since the outer (turbo) code performance is very close to that achieved on an AWGN channel

TABLE 2: Transmission mode table in the case of perfect channel SNR estimation.

Thr/put BER	4-QAM 1/2	4-QAM 2/3	4-QAM 3/4	16-QAM 1/2
$10^{-3}$	> 3.6	> 5.6	> 6.6	> 8.6
$10^{-4}$	> 4.2	> 6.4	> 7.6	> 9.2
$10^{-5}$	> 4.7	> 7	> 8.4	> 9.8
$10^{-6}$	> 5	> 7.6	> 8.9	> 10.7
Thr/put BER	16-QAM 2/3	16-QAM 3/4	64-QAM 2/3	64-QAM 3/4
$10^{-3}$	> 11	> 12.2	> 15.9	> 17.3
$10^{-4}$	> 11.7	> 12.9	> 16.5	> 17.9
$10^{-5}$	> 12.3	> 13.6	> 16.9	> 18.6
$10^{-6}$	> 13.1	> 14.5	> 17.5	> 19.8

with equivalent SNR. Ideally, an estimation process should be included for assessing system performance as a function of the actual measured channel, which would then be the input to the optimization. Using this procedure in Stingray, the related SNR fluctuation resulted in marginal performance degradation.

Based on those curves, and assuming perfect channel-SNR estimation at the receiver, the derived TMT is presented in Table 2.

By use of this table, the average system throughput (ST) for various BER requirements is presented in Figure 10. The system outage capacity (1%) is a good measure of throughput evaluation of the system and is also plotted in the same figure. The average capacity is also plotted, in order to show the difference from the performance upper bound.

The system throughput is very close to the 1% outage capacity, but it is 5 to 7 dB away from the performance limit, depending on the BER level. Since the system is adaptive, probably the 1% outage is not a suitable performance target for this system. The SNR gain achieved by going from one BER level to the next is about 0.8 dB. This marginal gain is expected due to the performance behavior of turbo codes (very steep performance curves at BER regions of interest).

### 5.3. Flexible algorithms for phase noise and residual frequency offset estimation

Omnipresent nuisances such as phase noise (PHN) and residual frequency offsets (RFO), which are the result of a nonideal synchronization process, compromise the orthogonality between the subcarriers of the OFDM systems (both SISO and MIMO). The resulting effect is a Common Error (CE) for all the subcarriers of the same OFDM symbol plus ICI. Typical systems adopt CE compensation algorithms, while the ICI is treated as an additive, Gaussian, uncorrelated per subcarrier noise parameter [34]. The phase-impairment-correction schemes developed in Stingray and WF can be implemented either by the use of pilot symbols or by decision-directed methods. They are transparent to the selection of the Space-Time coding scheme, and they are easily adaptable to any number of Tx/Rx antennas, down to the

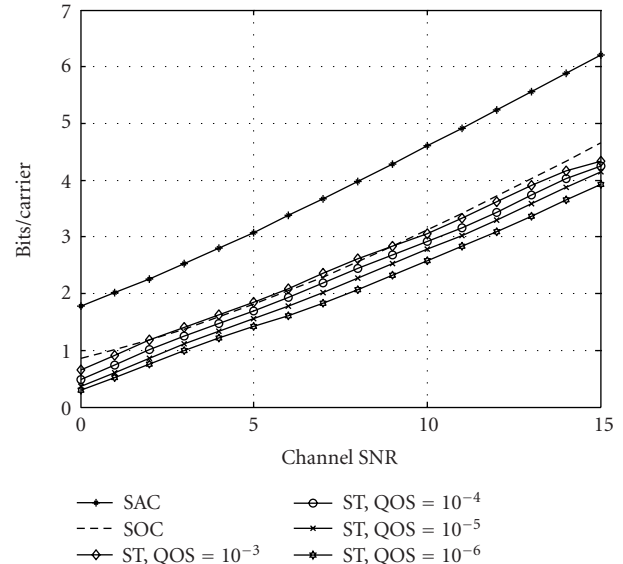

FIGURE 10: TSD-turbo system throughput (perfect CSI-SNR estimation).

$1 \times 1$  (SISO) case. In [35, 36] it is shown that the quality of the CE estimate, which is typically characterized by the Variance of the estimation error (VEE), affects drastically the performance of the ST-OFDM schemes. In [34, 35, 36] it is shown that the VEE is a function of the number and the position of the subcarriers used for estimation purposes, of the corresponding channel taps and of the pilot modulation method (when pilot-assisted modulation methods are adopted). Figure 11 depicts the dependence of the symbol error rate of an Alamouti STC OFDM system with tentative decisions on the number of subcarriers assigned for estimation purposes. It is clear that this system is very sensitive to the estimation error, and therefore to the selection of the corresponding “pilot” number.

Additionally, the working range of the decision-directed approaches is mainly dictated by the mean CE and the SNR, which should be such that most of the received symbols are within the bounds of correct decisions (i.e., the resulting error from the tentative decisions should be really small). This may be difficult to ensure, especially when transmitting high-order QAM constellations. An improved supervisor has to take into account the effect of the residual CE error on the overall system performance for selecting the optimal triplet, by inserting its effect into the overall calculations.

Two approaches can be followed for the system optimization. When the system protocol forces a fixed number of pilot symbols loaded on fixed subcarriers (as in Hiperman), the corresponding performance loss is calculated and the possible triplets are decided. It is noted that an enhanced supervisor device could decide on the use of adaptive pilot modulation in order to minimize estimation errors by maximizing the received energy, since the pilot modulation may significantly affect the system performance. Figure 12 depicts the effect of the pilot modulation method for the  $2 \times 2$  Alamouti

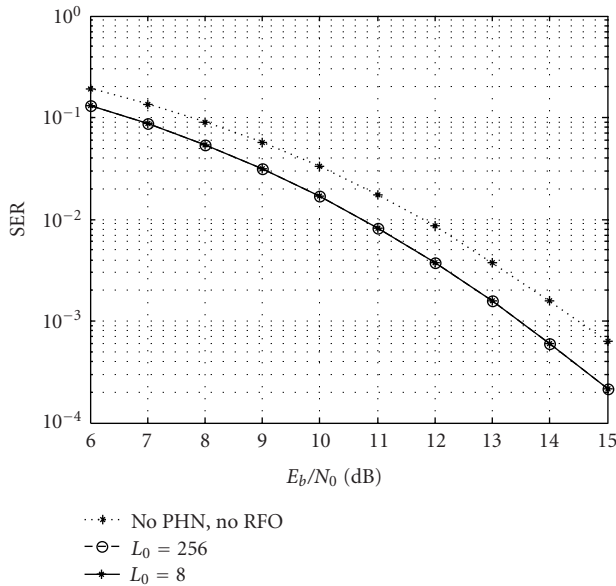

FIGURE 11: Effect of number of subcarriers used for estimation purposes on decision-directed,  $2 \times 2$  ST-OFDM system, Alamouti encoded, loaded with 16-QAM.

ST-OFDM system including 8 pilots, 256 subcarriers, and assuming independent compensation per receiver antenna for a realization of an SUI-4 channel. Three modulation methods are considered: randomly generated pilots (RGPs), orthogonal generated pilots (OGPs), and fixed pilot pattern (FPP), where the same pilots are transmitted from any Tx antenna. Thus, the selection of the pilot modulation scheme is another parameter to be decided, since it affects system performance in a significant way.

On the other hand, when the system protocol allows for a variable number of pilot symbols, the optimization procedure becomes more complex. After a training period of some OFDM symbols, the mean CE can be roughly estimated. Using this estimate and taking into account that the whole OFDM symbol is loaded with the same QAM constellation, it can be decided whether a specifically chosen constellation is robust to the CE, so that the decision directed methods (based on tentative decisions) are reliable. For the constellations where the pilot-symbol use is necessary, the supervisor has to select appropriately the position and the number of pilot symbols.

## 6. TOWARDS A FLEXIBLE ARCHITECTURE

As already mentioned, a flexible transceiver must be equipped with the appropriate robust solutions for all possible widely ranging environments/system configurations. To target the universally best possible performance translates to high complexity. A first step towards a generic flexible architecture should be one that efficiently incorporates simple tools in order to deliver not necessarily the best possible, but an acceptable performance under disparate system/channel environments.

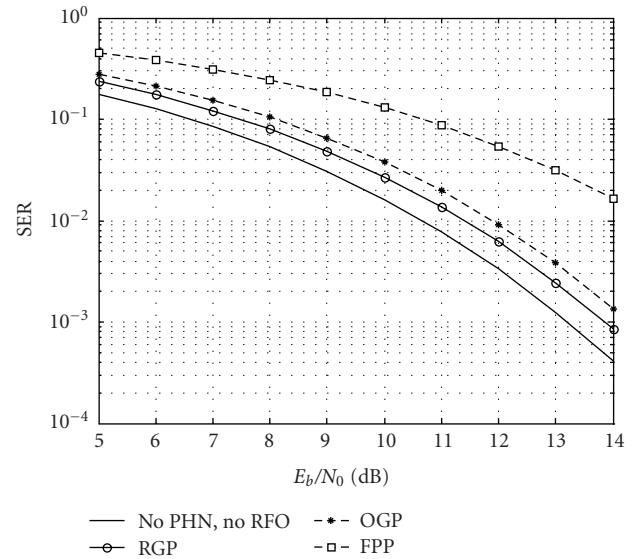

FIGURE 12: Effect of pilot modulation on  $2 \times 2$  ST-OFDM system, Alamouti encoded, loaded with 16-QAM ( $L_0 = 8$ ; 2 estimators).

The aforementioned CWSCE and TSD methods do belong to this category of flexible (partial) solutions. The capacity penalty for their use (compared to the optimal solutions) has been shown herein to be small. Both require common feedback information (1 bit/carrier) and can be incorporated appropriately in a system able to work under a variety of antenna configurations, when such limited feedback information is available. When feedback information is not available, CWSCE has the appropriate modules for mode selection (algorithm 1) for the SISO case, while Alamouti can be the choice for the MIMO case. Both STC schemes transform the MIMO channel into an inner SISO one, allowing for the use of AMC (mode selection) techniques designed for SISO systems. In the Stingray system, as already explained, the average ESNR at the demodulator is a sufficient metric for choosing the Tx mode, whereas in WIND-FLEX the uncoded BER is, respectively, used. Employing TMT tables with the required uncoded BER and code-rate/constellation-size sets for all the QoS operation modes in MIMO systems will increase the complexity, but it will permit seamless incorporation of both systems into one single common architecture. *The uncoded performance of the effective channel is thus the only metric that need be used for choosing the Tx mode and can be computed for a variety of STC options.* Furthermore, the fully parametric PHN and RFO algorithms mentioned above are transparent to the selection of the ST coding scheme and can provide the appropriate information about their performance under different environments/modes.

The overall block diagram of a proposed architecture for the mode selection algorithm is given in Figure 13. It is meant to be able to work for all systems employing one or two antennas at the Tx/Rx.

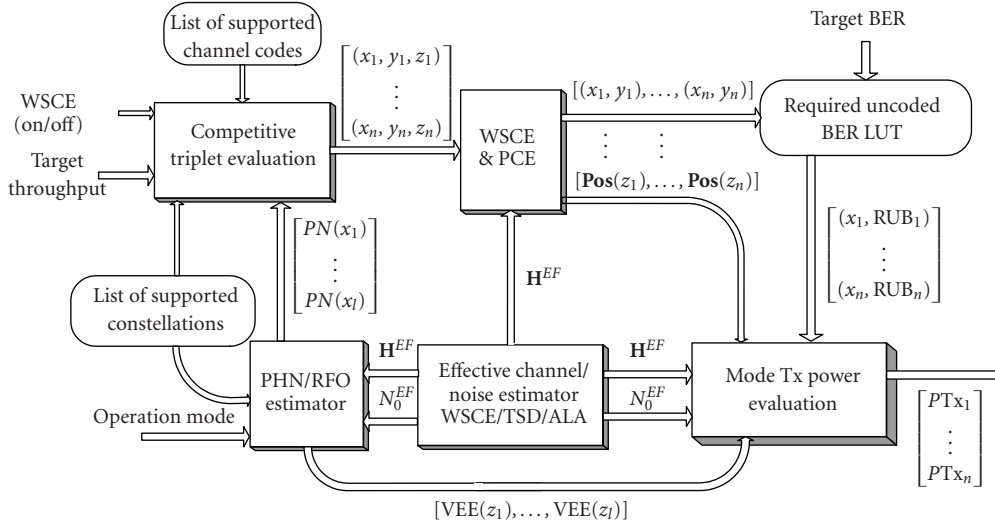

FIGURE 13: Block diagram of proposed algorithm for mode selection.

The related parameters are defined as follows:

- (i)  $PN(x_i)$ ,  $i = 1, \dots, l$ , is the number of needed pilots for a specific PHN/RFO performance, when the operation mode enables variable number of pilots;
- (ii)  $\hat{H}^{EF}$  is the vector of the estimated effective channel gains in the frequency domain (STC dependent);
- (iii) PCE : pilot carrier excision (an enhancement of the WSCE module which provides the pilot positions for a given number of used pilots).

Here, WSCE is active only when the system is  $1 \times 1$ . On all other Tx-Rx antenna choices, all subcarriers are assumed "on." When only a fixed number of pilot symbols are permitted (e.g., when a specific protocol is used), the PHN/RFO estimator provides the VEE for each constellation choice to the Tx power evaluation module. In a peer-to-peer communication system, where two flexible terminals could have the possibility of reconfiguring to a specific PHY, the number of pilots can be allowed to change and the optimum solution depends on the constellation size. The competitive-triplet evaluation must take this variable pilot number into account. The supervisor module is responsible for this optimization procedure. The best choice depends not only on the channel/system characteristics but also on the selected optimization criteria such as maximizing the throughput, minimizing the Tx power, and so on.

## 7. CONCLUSIONS

The scientific field of radio flexibility is growing in importance and appeal. Although still in fairly nascent form for commercial use, flexible radio possesses attractive features and attributes that require further research. The present paper presents the flexibility concept, definition, and related scenarios while, in parallel, explores in some depth the tool

of dynamic signal design for instantiating some of these attributes in a specific application environment. Two design approaches are presented (based on the WF and Stingray projects) and the key algorithmic choices of both are presented and incorporated into one flexible design capable of successfully operating in a variety of environments and system configurations. It is evident that physical-layer flexibility requires not only novel system architectures but also new algorithms that efficiently utilize existing and/or new modulation/coding techniques that can be adjusted to various environment and system scenarios, in order to offer QoS close to that delivered by corresponding point-optimal solutions.

## ACKNOWLEDGMENT

The work presented in this paper has been supported by STINGRAY (IST-2000-30173) and WIND-FLEX (IST-1999-10025) projects that have been partly funded by the European Commission.

## REFERENCES

- [1] A. Polydros, J. Rautio, G. Razzano, et al., "WIND-FLEX: developing a novel testbed for exploring flexible radio concepts in an indoor environment," *IEEE Commun. Mag.*, vol. 41, no. 7, pp. 116–122, 2003.
- [2] A. J. Goldsmith and S.-G. Chua, "Variable-rate variable-power MQAM for fading channels," *IEEE Trans. Commun.*, vol. 45, no. 10, pp. 1218–1230, 1997.
- [3] T. Keller and L. Hanzo, "Adaptive modulation techniques for duplex OFDM transmission," *IEEE Trans. Veh. Technol.*, vol. 49, no. 5, pp. 1893–1906, 2000.
- [4] F. K. Jondral, "Flexible spectrum allocation and cognitive radio," in *Proc. 11th National Symposium of Radio Science (URSI '05)*, pp. 27–32, Poznan, Poland, April 2005.

- [5] G. Masera, "Flexible hardware for wireless communications: a case of study," in *Proc. 11th National Symposium of Radio Science (URSI '05)*, Poznan, Poland, April 2005.
- [6] E. Buracchini, "The software radio concept," *IEEE Commun. Mag.*, vol. 38, no. 9, pp. 138–143, 2000.
- [7] J. Mitola and G. Maguire, "Cognitive radio: making software radios more personal," *IEEE Personal Communications Magazine*, vol. 6, no. 4, pp. 13–18, 1999.
- [8] R. van Nee and R. Prasad, *OFDM Wireless Multimedia Communications*, Artech House, Boston, Mass, USA, 2000.
- [9] R. Prasad and S. Hara, "Overview of multicarrier CDMA," *IEEE Commun. Mag.*, vol. 35, no. 12, pp. 126–133, 1997.
- [10] L. Hanzo, M. Munster, B. J. Choi, and T. Keller, *OFDM and MC-CDMA for Broadband Multi-User Communications, WLANs and Broadcasting*, John Wiley & Sons, New York, NY, USA, 2003.
- [11] L.-L. Yang and L. Hanzo, "Performance of generalized multicarrier DS-CDMA over Nakagami-fading channels," *IEEE Trans. Commun.*, vol. 50, no. 6, pp. 956–966, 2002.
- [12] L.-L. Yang and L. Hanzo, "Multicarrier DS-CDMA: a multiple access scheme for ubiquitous broadband wireless communications," *IEEE Commun. Mag.*, vol. 41, no. 10, pp. 116–124, 2003.
- [13] A. J. Paulraj, D. A. Gore, R. U. Nabar, and H. Bolcskei, "An overview of MIMO communications—a key to gigabit wireless," *Proc. IEEE*, vol. 92, no. 2, pp. 198–218, 2004.
- [14] M. Juntti, M. Vehkaperä, J. Leinonen, et al., "MIMO MC-CDMA communications for future cellular systems," *IEEE Commun. Mag.*, vol. 43, no. 2, pp. 118–124, 2005.
- [15] M. Vehkaperä, D. Tujkovic, Z. Li, and M. Juntti, "Layered space-frequency coding and receiver design for MIMO MC-CDMA," in *Proc. International Conference on Communications (ICC '04)*, vol. 5, pp. 3005–3009, Paris, France, June 2004.
- [16] J. Tang and X. Zhang, "Link-adaptation-enhanced dynamic channel allocation for MIMO-OFDM wireless networks," in *Proc. IEEE Wireless Communications and Networking Conference (WCNC '05)*, New Orleans, La, USA, March 2005.
- [17] J.-H. Deng, J.-Y. Wu, and T.-S. Lee, "Space-path spreading for high rate MIMO MC-CDMA systems with transmit diversity," in *Proc. IEEE Global Telecommunications Conference (GLOBECOM '03)*, vol. 6, pp. 3397–3401, San Francisco, Calif, USA, December 2003.
- [18] Y. Kim, T. Kim, C. Kang, and D. Hong, "Union bound of maximum likelihood detection in downlink MIMO MC-CDMA systems," in *Proc. International Conference on Communications (ICC '04)*, vol. 6, pp. 3280–3283, Paris, France, June 2004.
- [19] V. Tarokh, N. Seshadri, and A. R. Calderbank, "Space-time codes for high data rate wireless communication: performance criterion and code construction," *IEEE Trans. Inform. Theory*, vol. 44, no. 2, pp. 744–765, 1998.
- [20] Y. Gong and K. B. Letaief, "Concatenated space-time block coding with trellis coded modulation in fading channels," *IEEE Transactions on Wireless Communications*, vol. 1, no. 4, pp. 580–590, 2002.
- [21] B. Hochwald and S. ten Brink, "Achieving near-capacity on a multiple-antenna channel," *IEEE Trans. Commun.*, vol. 51, no. 3, pp. 389–399, 2003.
- [22] L. J. Cimini, "Analysis and simulation of a digital mobile channel using orthogonal frequency division multiplexing," *IEEE Trans. Commun.*, vol. 33, no. 7, pp. 665–675, 1985.
- [23] ETSI, "Broadband Radio Access Networks (BRAN)—HIPERMAN, OFDM Physical (PHY) layer," draft, 2002.
- [24] I. Dagres and A. Polydoros, "Dynamic transceivers: adaptivity and reconfigurability at the signal-design level," in *Proc. Software Defined Radio Technical Conference and Product Exposition (SDR '03)*, Orlando, Fla, USA, November 2003.
- [25] K. Babionitakis, I. Dagres, K. Nakos, and D. Reisis, "A VLSI architecture for minimizing the transmission power in OFDM transceivers," in *Proc. 10th IEEE International Conference on Electronics, Circuits and Systems (ICECS '03)*, vol. 1, pp. 308–311, Sharjah, United Arab Emirates, December 2003.
- [26] P. Chow, J. M. Cioffi, and J. A. C. Bingham, "A practical discrete multitone transceiver loading algorithm for data transmission over spectrally shaped channels," *IEEE Trans. Commun.*, vol. 43, no. 234, pp. 773–775, 1995.
- [27] G. Foschini and M. Gans, "On the limits of wireless communications in a fading environment when using multiple antennas," *Wireless Personal Communications*, vol. 6, no. 3, pp. 311–335, 1998.
- [28] M. Benedix, J. Ertel, and A. Finger, "Turbo coding for an OFDM-based wireless LAN at 17 GHz," in *Proc. 7th International OFDM-Workshop*, pp. 137–141, Hamburg, Germany, September 2002.
- [29] R. Knopp and G. Caire, "Power control and beamforming for systems with multiple transmit and receive antennas," *IEEE Transactions on Wireless Communications*, vol. 1, no. 4, pp. 638–648, 2002.
- [30] S. Alamouti, "A simple transmit diversity technique for wireless communications," *IEEE J. Select. Areas Commun.*, vol. 16, no. 8, pp. 1451–1458, 1998.
- [31] I. Dagres, A. Zalonis, and A. Polydoros, "An efficient adaptive space time coding scheme for MIMO-OFDM systems," in *Proc. 14th IST Mobile and Wireless Telecommunications Summit*, Dresden, Germany, June 2005, to appear.
- [32] I. Harjula, S. Boumard, and A. M. Gallardo, "WP4-Training symbol design for Stingray demonstrator," 2002, (document Stingray\_4VTTN009d.doc in IST-2000-30173 STINGRAY).
- [33] V. Erceg, K. V. S. Hari, M. S. Smith, and D. S. Baum, "Channel Models for Fixed Wireless Applications," 2001, IEEE 802.16.3 Task Group Contributions, Doc. IEEE 802.16.3.c-01/29r4.
- [34] K. Nikitopoulos and A. Polydoros, "Decision-directed compensation of phase noise and residual frequency offset in a Space-Time OFDM receiver," *IEEE Commun. Lett.*, vol. 8, no. 9, pp. 573–575, 2004.
- [35] K. Nikitopoulos and A. Polydoros, "Phase-impairment effects and compensation algorithms for OFDM systems," *IEEE Trans. Commun.*, vol. 53, no. 4, pp. 698–707, 2005.
- [36] K. Nikitopoulos and A. Polydoros, "Phase noise and residual frequency offset compensation in space-time OFDM systems," in *Proc. IST Mobile and Wireless Telecommunications Summit*, pp. 77–82, Aveiro, Portugal, June 2003.

**Ioannis Dagres** holds a B.S. degree in computer engineering and an M.S. degree in signal processing from the Technical University of Patras, Greece, in 1997 and 1999, respectively. He is currently working towards his Ph.D. degree at the same university. Since 1999, he has participated in several EU projects such as ADAMAS (ADaptive Multicarrier Access System), WIND-FLEX (Wireless INDoor FLEXible Modem Architecture), and STINGRAY (Space Time CODING for Adaptive Reconfigurable Systems) as a Research Associate. His research interests include the topics of signal processing for communications and, in particular, adaptive signal design for modern communication systems.



**Andreas Zalonis** received the B.S. degree in physics and the M.S. degree in telecommunications and electronics, both from the National Kapodistrian University of Athens (NKUA), Greece, in 2000 and 2002, respectively. He is currently working towards his Ph.D. degree in fourth-generation digital communications systems at the same university. Since 2001, he has participated in several national and European research projects in the area of wireless communications. Since 2003 he works as a Research Associate in the Institute of Accelerating Systems and Applications (IASA), NKUA.



**Nikos Dimitriou** holds a Diploma degree in electrical and computer engineering from the National Technical University of Athens, Greece (1996), an M.S. degree with distinction in mobile and satellite communications from the University of Surrey, United Kingdom (1997), and a Ph.D. degree from the same University (2000). During that period his work was focused on radio resource management issues and techniques for next-generation mobile multimedia communication systems (UMTS, W-CDMA). He participated in projects related to traffic modeling and network dimensioning for UMTS and GPRS (led by Ericsson and One2One), worked as an MSc tutor and supervised various MSc projects. Since 2001, he has been working in the National Kapodistrian University of Athens and specifically in the Institute of Accelerating Systems and Applications (IASA), as a Senior Research Associate, coordinating the involvement of the institute in several EU-IST projects such as ADAMAS (ADaptive Multicarrier Access System), WIND-FLEX (Wireless INDoor FLEXible Modem Architecture), SATIN (SATellite UMTS Ip Network), STINGRAY (Space Time CodING for Adaptive Reconfigurable Systems), and in the Network of Excellence in Wireless Communications (NEWCOM). His research is focused on cross-layer optimization techniques for next-generation flexible wireless systems.



**Konstantinos Nikitopoulos** was born in Athens, Greece, in 1974. He received the B.S. degree in physics and the M.S. degree in electronics and telecommunications from the National Kapodistrian University of Athens (NKUA), Athens, Greece, in 1997 and 1999, respectively. Since 2005, he holds a Ph.D. degree from the same university. Since 1999, he has been a Research Associate at the Institute of Accelerating Systems and Applications, Athens, Greece, and has participated in several EU research projects. Since October 2003, he has been with the General Secretariat for Research and Technology of the Hellenic Ministry of Development, Athens, Greece. Since October 2004, he has been also a part-time Instructor in the Electrical Engineering Department, the Technological Educational Institute of Athens, Athens, Greece. His research interests include the topics of signal processing for communications and, in particular, in synchronization for multicarrier systems. Dr. Nikitopoulos is a National Delegate of Greece to the Joint Board on Communication Satellite Programmes of the European Space Agency (ESA).



**Andreas Polydoros** was born in Athens, Greece, in 1954. He received the Diploma in electrical engineering from the National Technical University of Athens in 1977, the M.S.E.E. degree from the State University of New York at Buffalo in 1979, and the Ph.D. degree in electrical engineering from the University of Southern California in 1982. He was a faculty member in the Department of Electrical Engineering-Systems and the Communication Sciences Institute (CSI), the University of Southern California, in 1982–1997, and has been a Professor since 1992. He codirected CSI in 1991–1993. Since 1997, he has been a Professor and Director of the Electronics Laboratory, Division of Applied Physics, Department of Physics, University of Athens, Greece. His general areas of scientific interest are statistical communication theory and signal processing with applications to spread-spectrum and multicarrier systems, signal detection and classification in uncertain environments (he is the coinventor of per-survivor processing, granted a US patent in 1995), and multiuser radio networks. He cofounded and currently heads the Technology Advisory Board of Trellis Ware Technologies, and also serves on numerous scientific boards of academic nonprofit organizations in Greece and abroad. Professor Polydoros is the recipient of a 1986 US National Science Foundation Presidential Young Investigator Award. He became a Fellow of the IEEE in 1995, cited “for contributions to spread-spectrum systems and networks.”

